

# PART I CERTIFICATION EXAMINATIONS

Attaining ABFAS Board Qualified Status

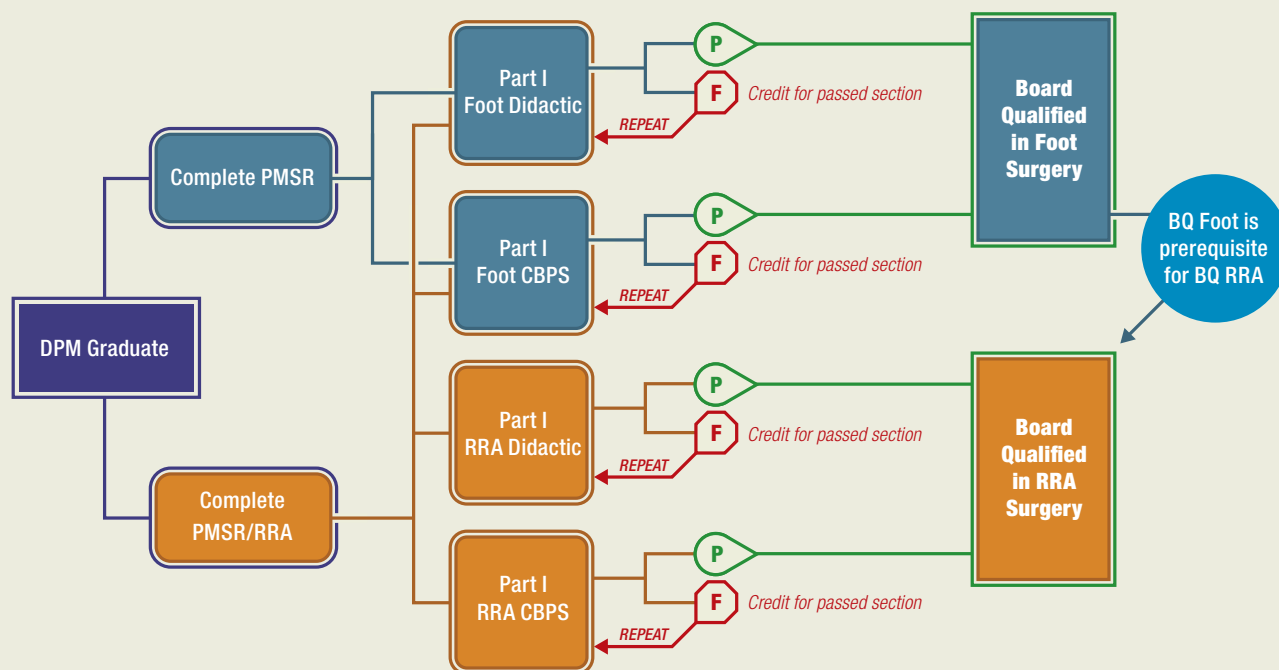

## NOTES

All candidates applying for Board Qualified must submit residency logs through Podiatry Residency Resource (PRR).

Candidates completing other residency types prior to June 30, 2014:

**PM&S-36:** If currently Board Qualified, may requalify for additional seven years (but no more than total of 14 years).

**PM&S-24:** If currently Board Qualified, may

requalify, but requalification shall not extend beyond 2018.

**PSR-12 plus any other residency:** If currently Board Qualified, may requalify, but requalification shall not extend beyond 2018.

**PM&S-36:** If not Board Qualified, may qualify for seven years (but no more than total of 14 years).

**PM&S-24:** If not Board Qualified, may qualify, but qualification shall not extend beyond 2018.

**PSR-12 plus any other residency:** If not Board Qualified, may qualify, but qualification shall not extend beyond 2018.

Residents receiving training certificates in 2014 and beyond have seven years to achieve Board Certified status.

*Didactic = multiple-choice questions*

*CBPS = Computer-based Patient Simulation*